



SUBMITTAL DATA - **OUTDOOR UNIT**

VRA072L4M-2Y

VRF LOW AMBIENT HEAT RECOVERY

Job: _____

Location: _____

Schedule No.: _____

System Designation: _____

Engineer: _____

Architect: _____

Date: _____

For: Reference Approval Review Construction

FEATURES

- 75% Heating Capacity at -13°F
- 100% Heating Capacity at 15°F
- Built-in Base Pan Heater
- Hinged electrical box for ease of maintenance
- High efficiency DC Inverter scroll compressor

SPECIFICATIONS

PERFORMANCE

Cooling Capacity ¹ (Btu/h)	Nominal	72,000
	Rated ²	69,000
EER	Ducted	11.80
	Non-Ducted	13.00
IEER	Ducted	21.50
	Non-Ducted	23.00
Simultaneous Heating and Cooling Efficiency (SCHE)	Ducted	26.10
	Non-Ducted	30.00
Heating Capacity ¹ (Btu/h)		77,000
COP47	Ducted	3.68
	Non-Ducted	4.05
COP17	Ducted	2.25
	Non-Ducted	2.53

ELECTRICAL DATA

Power Supply ³ (V/Hz/Ph)	208-230/60/3
Minimum Circuit Ampacity (A)	54.7
Maximum Overcurrent Protection (A)	70
Compressor RLA (A)	20/19
No. of Compressors	2
Outdoor Fan Power Input (W)	750/750
Outdoor Fan FLA (A)	4.1/4.1

GENERAL DATA

Connection Ratio	50% to 130%
Max # of Indoor Units	13 units
Refrigerant type	R-410A
Factory refrigerant charge	22 lbs.

DIMENSIONS

Unit Dimensions (in)	Height	63-1/8
	Width	49-1/4
	Depth	30-1/8
Liquid Pipe Connection (in.)		1/2
Gas Pipe Connection (in.)		7/8
Net Weight (lb)		770



WARRANTY⁴

- Compressor - 10 year limited warranty
- All other components - 10 year limited warranty

NOTES

1. Cooling and Heating Capacity data is rated at the following conditions:
Cooling: 80°FDB / 67°FWB Indoor, 95°FDB Outdoor
Heating: 70°FDB Indoor, 47°FDB / 43°FWB Indoor
2. Complies with AHRI 1230-2014 testing standards
3. Operating Voltage Range: 191V to 247V
4. See Warranty for Details





SUBMITTAL DATA - **OUTDOOR UNIT**

VRA072L4M-2Y

VRF LOW AMBIENT HEAT RECOVERY

DIMENSIONS - INCHES (MM)

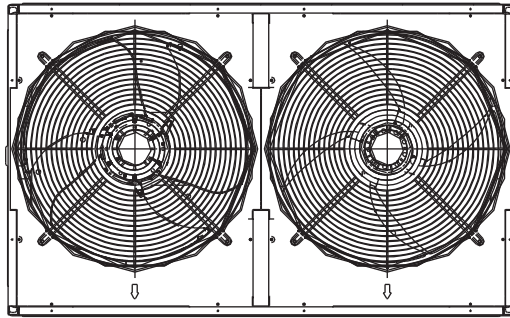

TOP VIEW

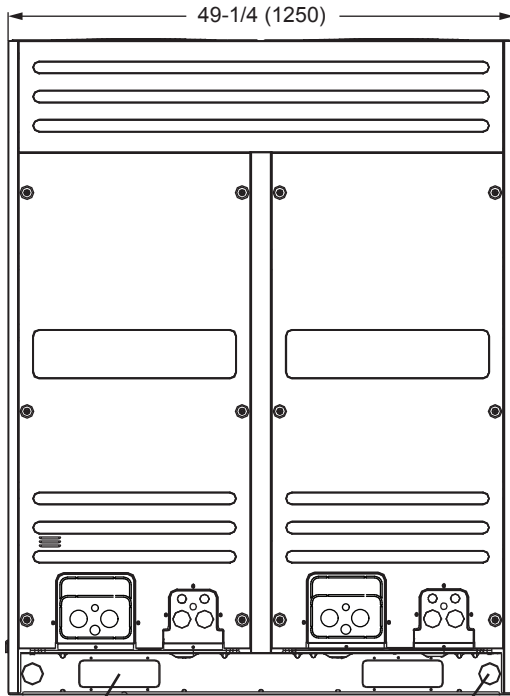

FORKLIFT SLOT
(BOTH SIDES)

LIFTING HOLES
(FOR RIGGING)

FRONT VIEW

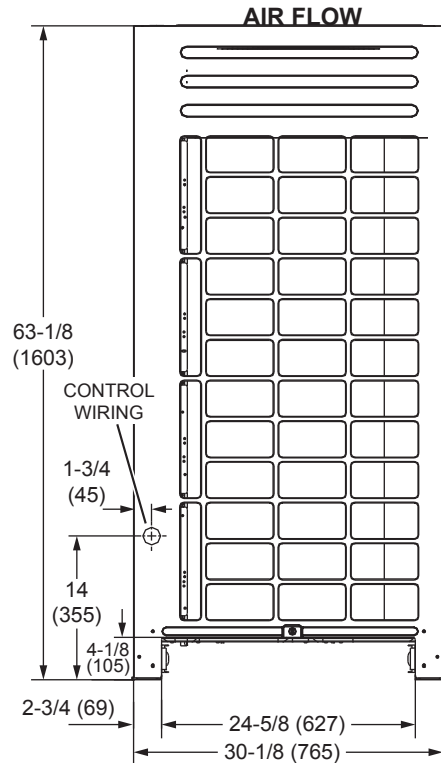

AIR FLOW

AIR FLOW

SIDE VIEW

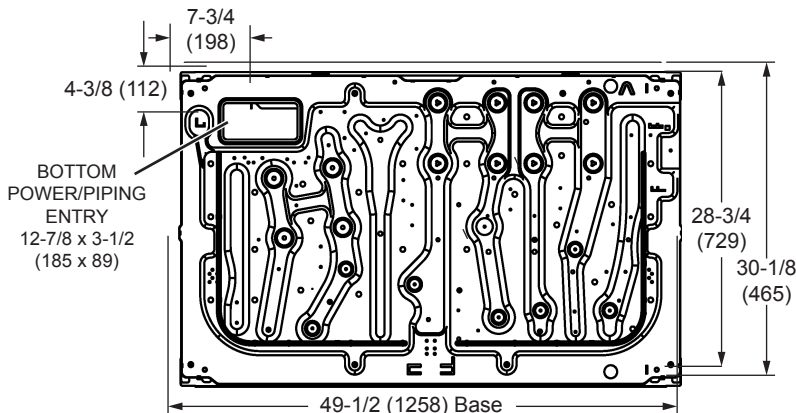

BOTTOM
POWER/PIPING
ENTRY
12-7/8 x 3-1/2
(185 x 89)

BASE VIEW

DISCLAIMER – Due to Lennox' ongoing commitment to quality, Specifications, Ratings and Dimensions subject to change without notice and without incurring liability. Improper installation, adjustment, alteration, service or maintenance can cause property damage or personal injury. Installation and service must be performed by a qualified installer and servicing agency.