



SUBMITTAL DATA - **OUTDOOR UNIT** **VPA036H4M-2P** **VRF HEAT PUMP**

Job: _____
Location: _____
Schedule No.: _____
System Designation: _____

Engineer: _____
Architect: _____
Date: _____
For: Reference Approval Review Construction

FEATURES

- Two-pipe heat pump
- High efficiency twin rotary compressor
- Smooth Sine wave DC inverter
- Built-in base pan heater
- Power meter interface
- Intelligent soft start

WARRANTY

- Compressor - 10 year limited warranty
- All other components - 10 year limited warranty
- *See warranty for details

SPECIFICATIONS

PERFORMANCE

Cooling Capacity ¹ (Btu/h)		36,000
EER	Ducted	11.30
	Non-Ducted	10.70
SEER	Ducted	17.20
	Non-Ducted	17.20
Heating Capacity ¹ (Btu/h)		40,000
HSPF (Region IV)	Ducted	9.20
	Non-Ducted	8.90

ELECTRICAL DATA

Power Supply ² (V/Hz/Ph)	208-230/60/1
Minimum Circuit Ampacity (A)	33
Maximum Overcurrent Protection (A)	50
Compressor RLA (A)	24.3
No. of Compressors	1
Outdoor Fan Power Output (W)	85/85
Outdoor Fan FLA (A)	1.1/1.1

GENERAL DATA

Connection Ratio	45% to 130%
Max. # of Indoor Units	5 units
Sound Pressure Level (dBA) - CLG / HTG	41 / 44
Outdoor Fan Total Air Volume (cfm)	4100
Refrigerant type	R-410A
Factory refrigerant charge	8 lbs. 6 oz.

DIMENSIONS

Unit Dimensions (in)	Height	52-1/4
	Width	35-3/8
	Depth	13-1/4
Liquid Pipe Connection (in)		3/8
Gas Pipe Connection (in)		3/4
Shipping Weight (lb)		243
Net Weight (lb)		220



NOTES

1. Cooling and Heating Capacity data is rated at the following conditions:
Cooling: 80°FDB / 67°FWB Indoor, 95°FDB Outdoor
Heating: 70°FDB Indoor, 47°FDB / 43°FWB Indoor
2. Operating Voltage Range: 191V to 247V





SUBMITTAL DATA - **OUTDOOR UNIT**
VPA036H4M-2P
VRF HEAT PUMP

DIMENSIONS - INCHES (MM)

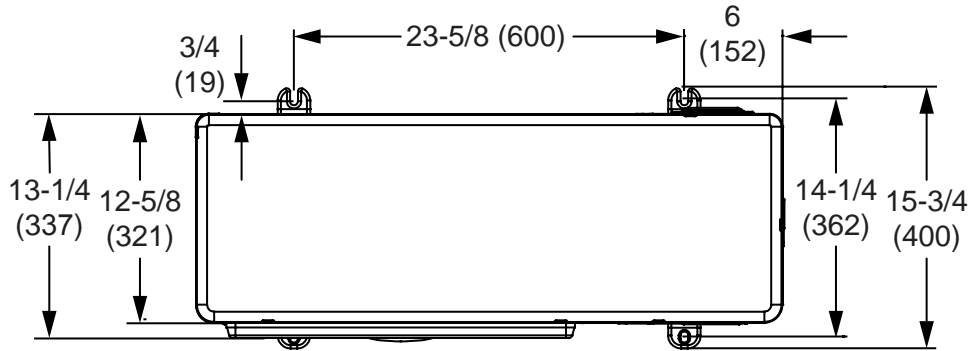

TOP VIEW

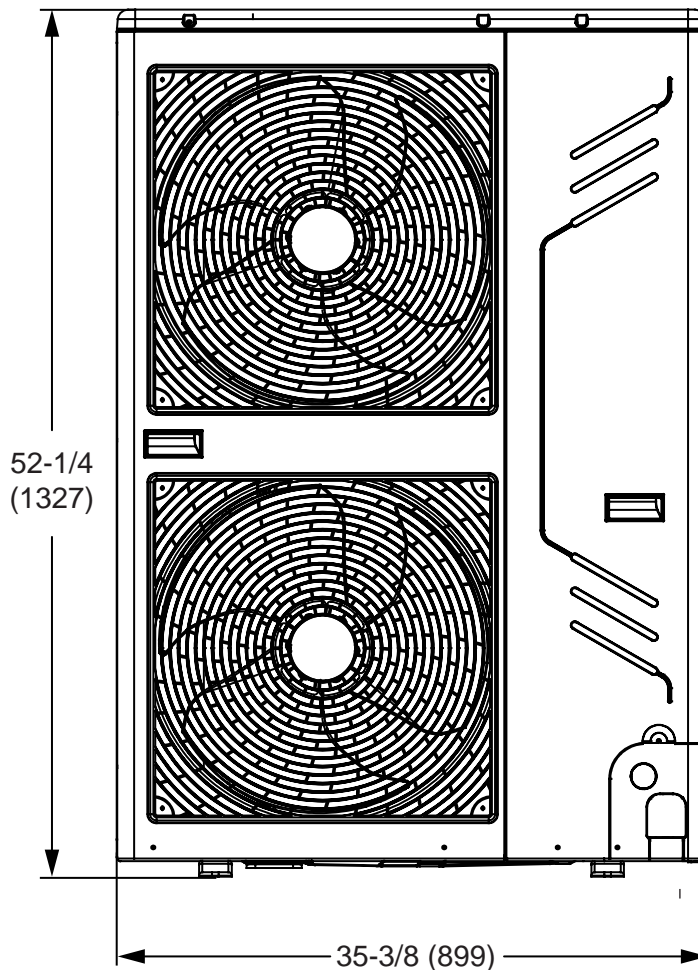

FRONT VIEW

DISCLAIMER – Due to Lennox' ongoing commitment to quality, Specifications, Ratings and Dimensions subject to change without notice and without incurring liability. Improper installation, adjustment, alteration, service or maintenance can cause property damage or personal injury. Installation and service must be performed by a qualified installer and servicing agency.

495465 (201805)

©2018 Lennox Industries Inc.